

### Features

- Ergonomic lever handle is ADA-compliant.

### Installation

- Patented K-joint installation technology ensures consistent trim appearance, regardless of variability in valve rough-in.
- Wall-mount.
- Trim only; requires valve to complete installation (sold separately).

### Required Products/Accessories

K-728-K 3/4" Two- or Three-Way Transfer Valve

### Recommended Products/Accessories

K-23723 Faucet cleaner



ADA

CSA B651

OBC

### Codes/Standards

ASME A112.18.1/CSA B125.1

ADA

ICC/ANSI A117.1

CSA B651







OBC

### KOHLER® Faucet Lifetime Limited Warranty

See website for detailed warranty information.

### Available Colors/Finishes

*Color tiles intended for reference only.*

Color	Code	Description
	CP	Polished Chrome
	PB	Vibrant® Polished Brass
	BN	Vibrant® Brushed Nickel
	BV	Vibrant® Brushed Bronze
	BRZ	Oil-Rubbed Bronze
	2BZ	Oil-Rubbed Bronze

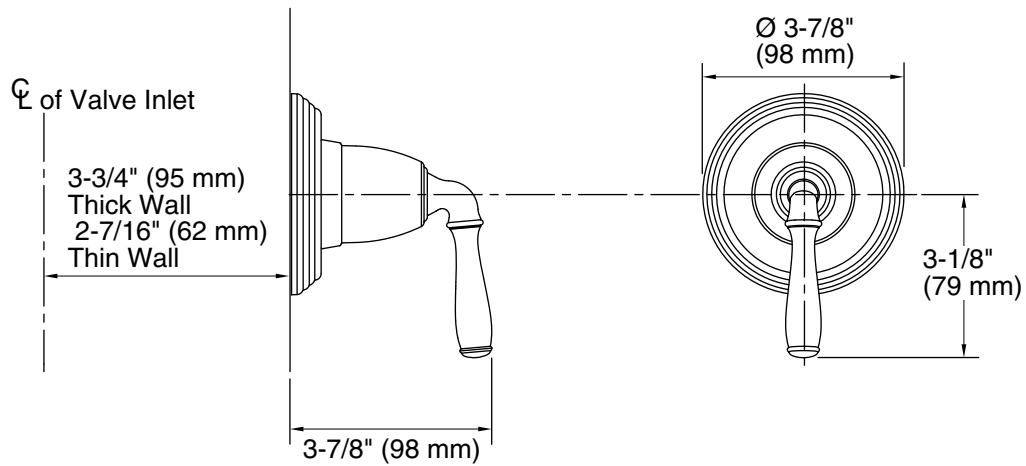

### Technical Information

All product dimensions are nominal.

### Notes

Install this product according to the installation guide.

ADA, OBC, CSA B651 compliant when installed to the specific requirements of these regulations.